

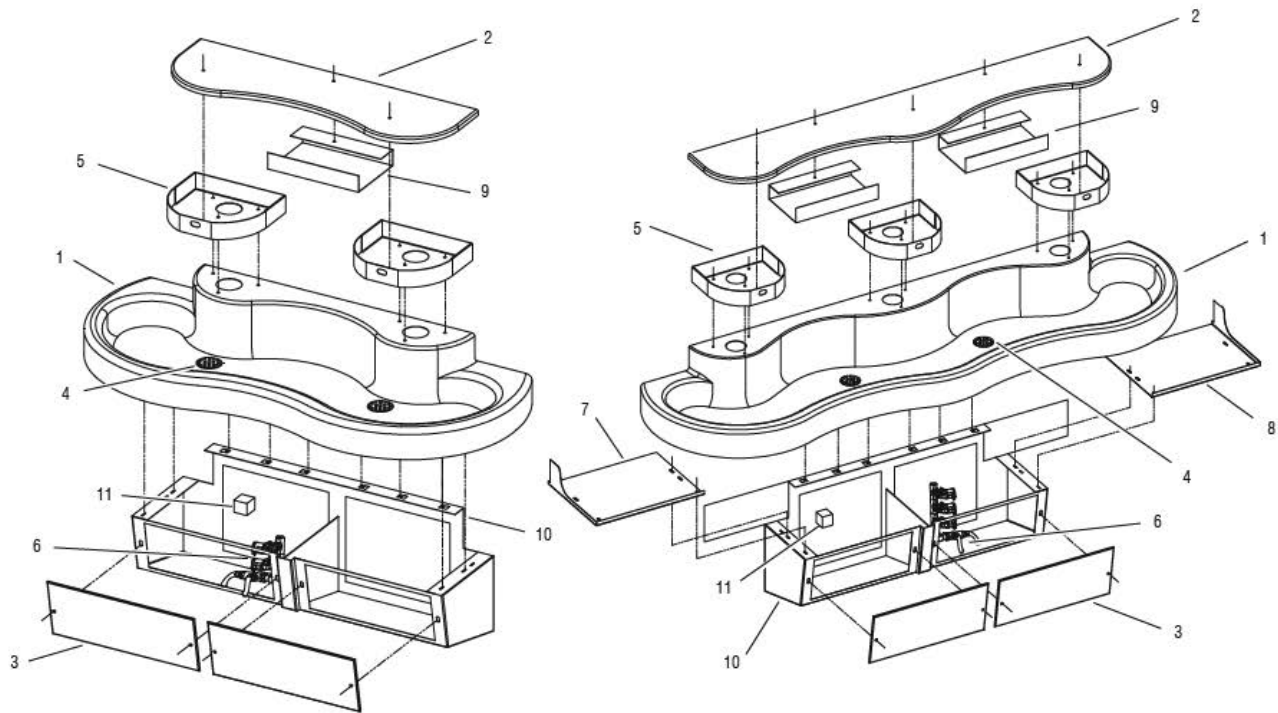









SloanStone® EW-42000/43000 Sinks



Hardware Kit

- 1/4-20 x 4" THREADED ROD 
- 1/4-20 x 1 1/2" FASTENER 
- 1/4-20 x 1" FASTENER 
- 1/4-20 x 1" FASTENER (FLAT HEAD) 
- 1/4-20 x 1/2" FASTENER 

- 1/4-20 x 7/8" COUPLING NUT 
- 4 WAY WIRE TIE BASE 
- AERATOR KEY 

- 4" WIRE TIE WRAP 
- 1/4-20 TINNEMAN NUT 
- 1/4-20 WING NUT 
- TT30 PINNED TORX BIT 
- TT27 PINNED TORX BIT 

Item No.	Description
1.	Sold Surface Basin
2.	Solid Surface Top Cover
3.	Front Panels
4.	Front Panels (LP)
5.	Actuator Assembly
6.	Electronic Valve Assembly
7.	Left Side Closure Panel
8.	Right Side Closure Panel
9.	Filler Tray/Soap Tray
10.	Cabinet (LP)
	Cabinet (Standard)
	Cabinet (Floor Mounted)
	Power Supply
11.	Hardware Kit (Not Shown)

Part No.	Description
	MIXING VALVE
	MIX-135-A Below Deck Thermostatic Mixing Valve (BDT Variation)
	SENSOR REPLACEMENT KIT
	EL-1500-LL
	SOLENOID REPLACEMENT KIT
	ETF-1004-A
	SOLENOID FILTER REPLACEMENT KIT
	ETF-1009-A